

4 3 2 1

F

F

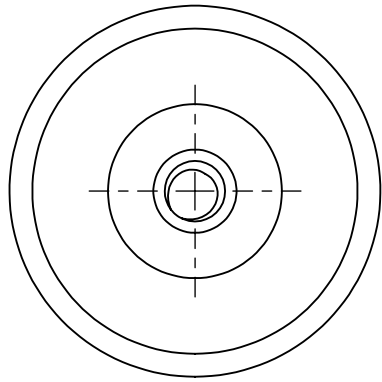

E

E

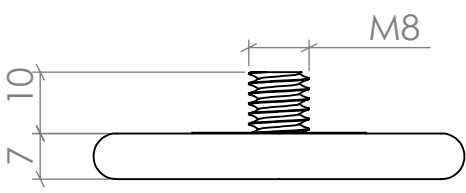

D

D



C

C

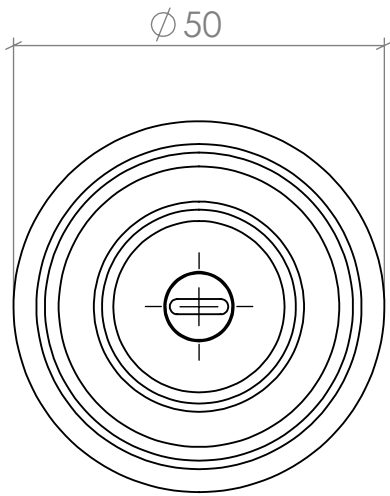

B

B

SI NO SE INDICA LO CONTRARIO:
 LAS COTAS SE EXPRESAN EN MM
 ACABADO SUPERFICIAL:
 TOLERANCIAS:
 LINEAL:
 ANGULAR:

ACABADO:

REBARBAR Y
 ROMPER ARISTAS
 VIVAS

NO CAMBIE LA ESCALA

REVISIÓN

	NOMBRE	FIRMA	FECHA	
DIBUJ.				
VERIF.				
APROB.				
FABR.				
CALID.				

TÍTULO:	
N.º DE DIBUJO	04860022
PESO:	
ESCALA:1:1	HOJA 1 DE 1

A4

A

A

4 3 2 1