

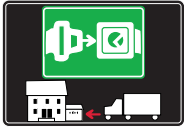

Maori

SYMBOLS



= SHELF SAFELY LOCKED DURING TRANSPORTATION AND AT HOME.



= ANTI-TURNOVER LOCKING SYSTEM



= NORMS / PATENTS



= PHILLIPS / POZIDRIV



= WITH BUFFER



= PART NO.



= BLADE SLOT



= WITH MAGNET



= PCS. PER PACKAGE



= COMBI SLOT



= NEWTON



= CAPACITY LOADING



= HEXALOBULAR SOCKET



= FRICTION



= WOOD / GLASS THICKNESS



= COUNTERSUNK HEAD



= AUTOMATIC



= HOLE DIAMETER



= PAN HEAD



= DROP DOWN



= DIAMETER



= FLANGE HEAD



= LENGTH



= FLAT HEAD



= STANDARD HINGE



= HEIGHT



= TRILOBULAR SCREW



= KIMANA HINGE



= RIGHT VERSION



= SELF-TAPPING SCREW



= FLAP HINGE



= LEFT VERSION



= EURO THREAD



= WITH SPRING



= SETTING CODE



= METRIC THREAD



= WITHOUT SPRING



= PCS. PER PAD



= PRE-INSERTED SCREW



= REVERSED SPRING



= CUT ON REQUEST



= PRE-INSERTED SCREW AND SPREADING BUSH



= SELF ADHESIVE



= WITH FLANGE

NOTE: Printing errors and omissions may exist despite our best efforts to ensure accuracy. We reserve the right to alter specifications without notice.



MATERIALS

ZA = Zinc Alloy

ST = Steel

HSS = High Speed Steel

BR = Brass

ABS = Acrylonitrile Butadiene Styrene

ZAnk = Nickel-plated Zinc Alloy

STzk = Zinc-plated Steel

AL = Aluminium

WD = Wood

EVA = Ethylene Vinyl Acetate

EP = **ENGINEERING PLASTIC**

+ **EP** = other engineering plastic available on request

SR = **SOFT RUBBER**

+ **SR** = other soft rubber available on request

EPn = Natural Engineering Plastic

EPc = Clear Engineering Plastic

SRn = Natural Soft Rubber

EPw = White Engineering Plastic

EPg = Grey Engineering Plastic

SRw = White Soft Rubber

EPwg = Water Green Engineering Plastic

EPa = Anthracite Engineering Plastic

SRb = Black Soft Rubber



FINISHES



+ **OTHER FINISHES AVAILABLE ON REQUEST**

PART NO.	FINISHES	PART NO.	FINISHES	PART NO.	FINISHES
OO	Insignificant finish	IF	Middle Grey	RO	Red
AA	Natural	IJ	Light Grey	UT	T-Met 9007
AB	White	IL	Grey 20	UZ	T-Met
AE	White 9010	IN	Grey met. 26	WA	Bronzed
EA	Black	JB	Bright Aluminium	WI	Burnished
EC	Matt Black	JC	Aluminium - Chrome	XD	Satin-finished Steel
EE	Anthracite	JD	Matt Aluminium	YA	Nickel-plated
EW	Grey 9007	JE	Satin-finished Aluminium	YB	Bright Nickel-plated
FU	Gunmetal	JF	Aluminium - Brass	YC	Matt Nickel-plated
FV	Gunmetal V52	JG	Aluminium 5	YD	Satin-finished Nickel-plated
GR	Raw	JL	Aluminium PE 11	YQ	Black Nickel
HA	Brass-Plated	JM	Aluminium RAL 9006	Z9	Black Zinc
HH	Tropicalized	KA	Chrome	ZA	Zinc alloy
HL	Raw Brass	KB	Bright Chrome	ZN	Zinc-plated
HX	Graphite	KC	Matt Chrome	ZQ	Bright Gold
IA	Grey	LD	Brown 8019	ZY	Titanium
IB	Metallic Grey	NN	Metallic Beige	ZZ	Clear

MAORI - Flush installation



12 mm min.

Certificates available on request.

SPECIFICATIONS

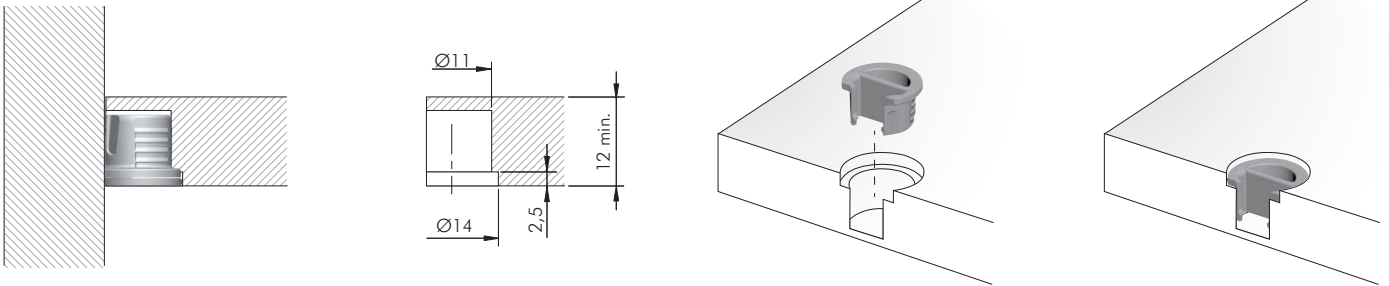

INSTALLATION AND ASSEMBLING

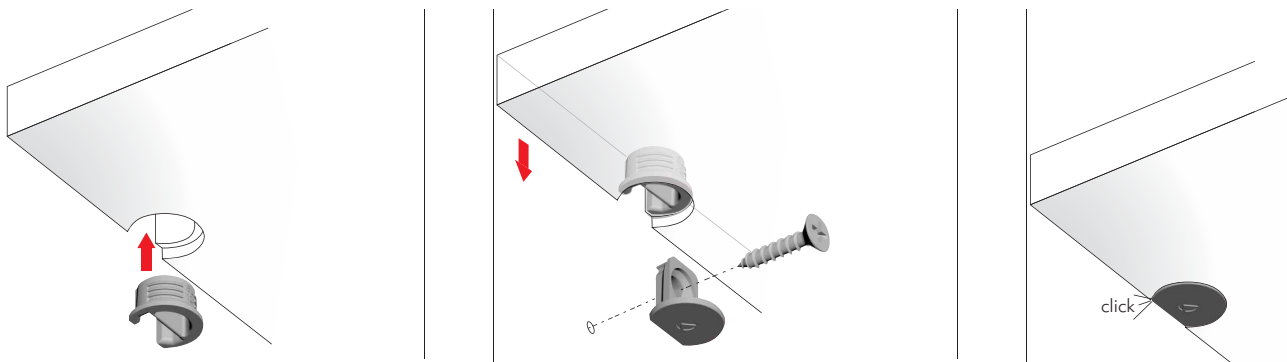

FIXING OPTIONS FOR SIDE PANEL BRACKET

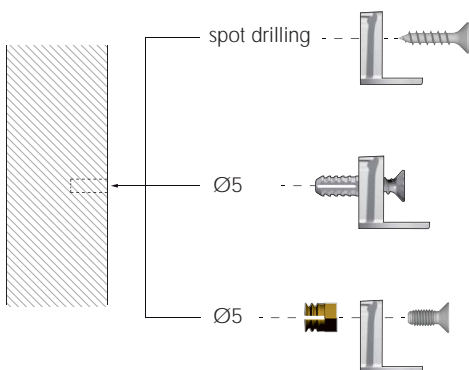

TEMPLATE (for assembling see the related section)

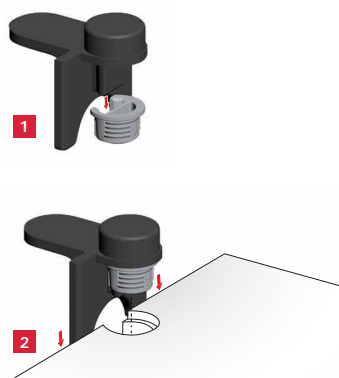

OPTIONAL FIXING (12mm thick version excluded): To achieve much more horizontal connection.

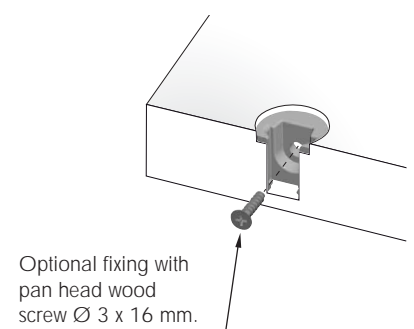

MAORI - Step installation

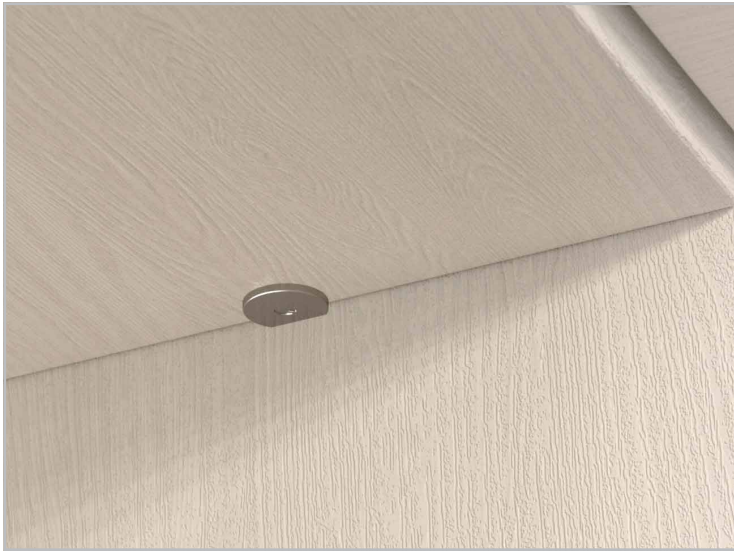

15 mm min.

Certificates available on request.

SPECIFICATIONS

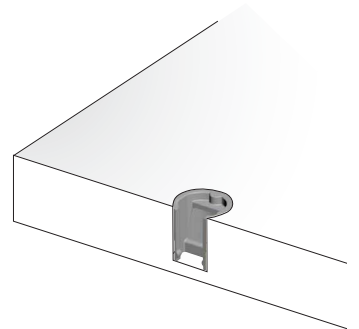
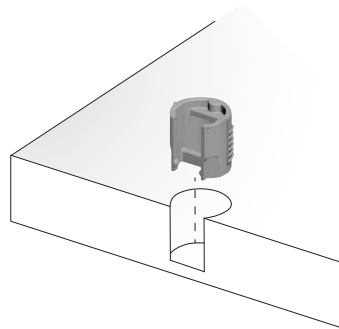
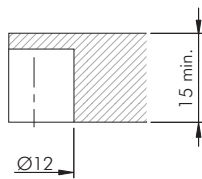
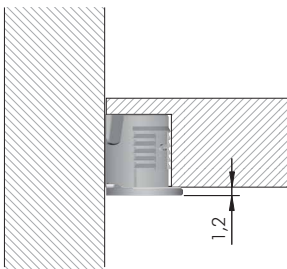

INSTALLATION AND ASSEMBLING

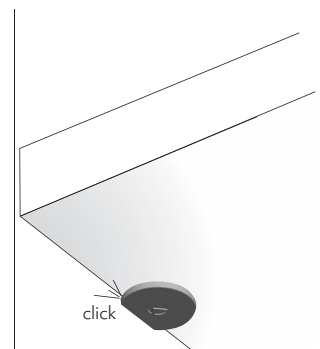
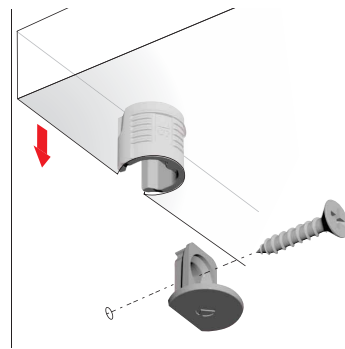
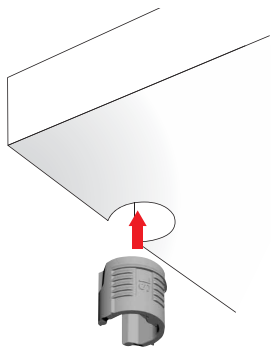

FIXING OPTIONS FOR SIDE PANEL BRACKET

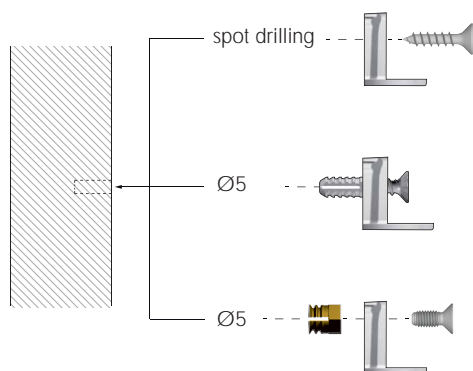

TEMPLATE (for assembling see the related section)

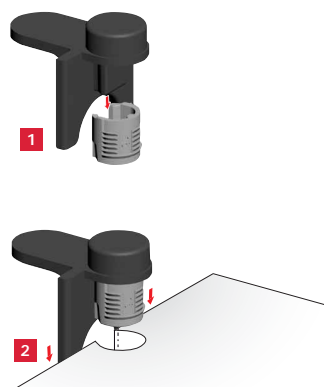

OPTIONAL FIXING WITH NAILER:

To achieve much more horizontal connection.

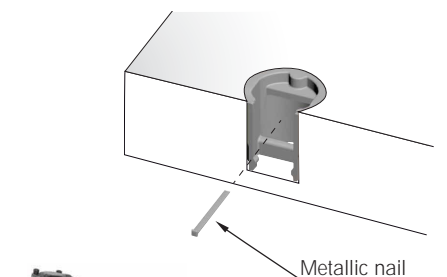

We recommend to use an electric or pneumatic nailer.

MAORI TEMPLATE

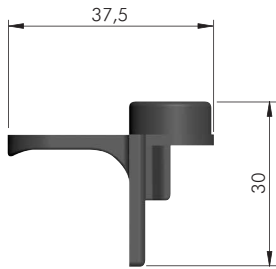
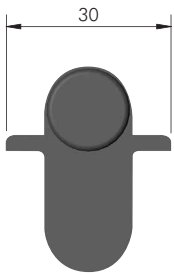
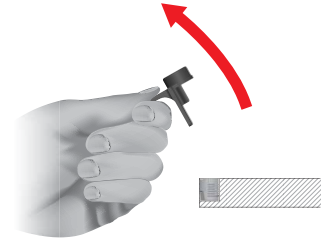
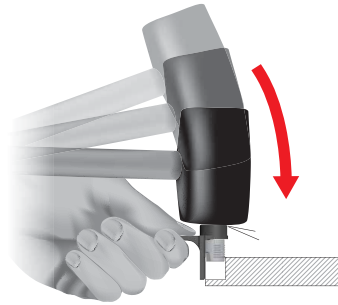
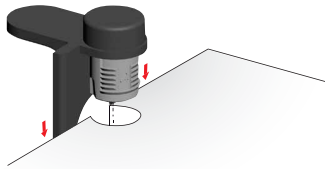



EPb	= on request
1175209000	

MAORI  **18 - 19 mm**

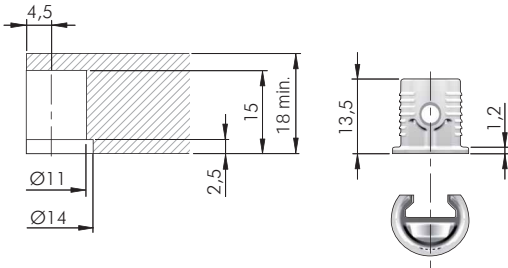

FLUSH INSTALLATION





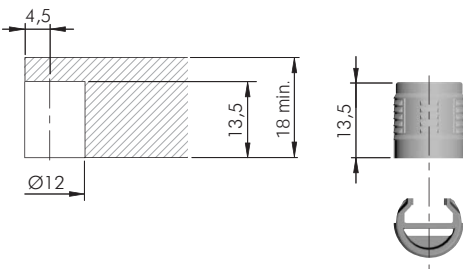

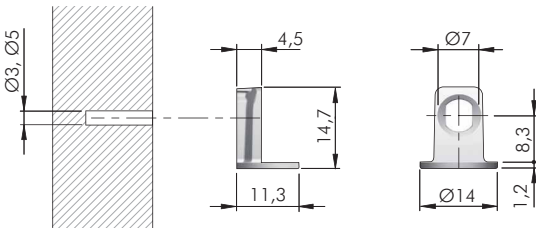

EP	 = 15.000 pcs.
 123 	
11701070IL	

STEP INSTALLATION









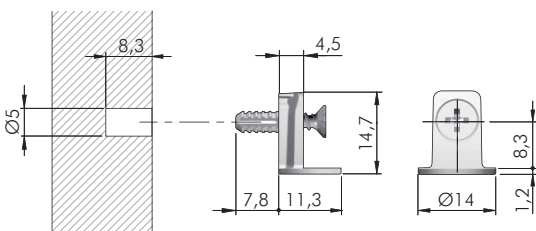

EP	 = 15.000 pcs.
 123 	
11701160IL	









 = Ø 3, Ø 5 mm	 + 
ZA	 = 5000 pcs.
 123 	
11710010YA	

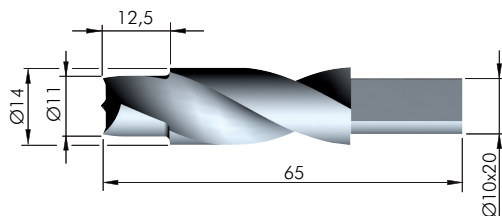
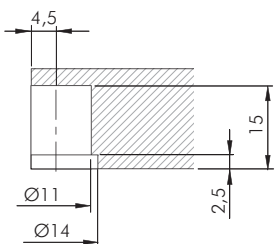

 = Ø 5 mm	 + 
  = PZ2	
ZA ST EP	 = 2500 pcs.
 123 	
11710030YA	

DRILL BIT FOR MAORI  **18 - 19 mm - Flush installation**



HSS	 = on request
 123 	
1175203000	
1175207000	

MAORI FIXING ACCESSORIES

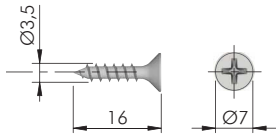

 = Ø 3 mm
 + 







 = PZ2

 ST
  = 10.000 pcs.

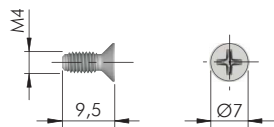



60101390Z





 = PZ2
 + 

 = M4

 ST
  = 10.000 pcs.



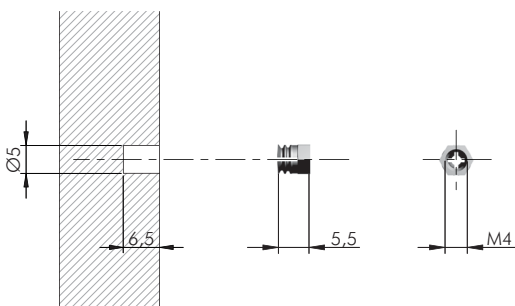

11750010Z



 = Ø 5 mm

 = M4

 BR
  = 5000 pcs.



20502000HL