

NILA 19 Perfil vertical. Para una puerta con tablero de 19mm. de espesor
Diseño estándar. **Venta por barras sueltas**

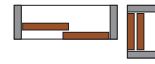

SP19

PERFIL VERTICAL TIRADOR

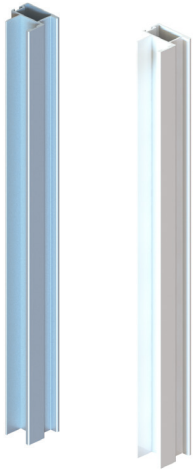

PERFIL HORIZONTAL

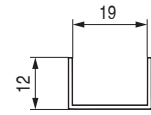
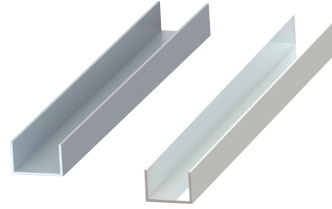

CÓDIGO	largo	Material	Acabado	
399.73	4m.	aluminio	plata mate	1/20
399.74	4m.	aluminio	lacado blanco	1/20

CEPILLO SALVAPOLVO

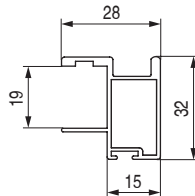
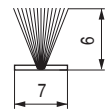

ACTUALIZADO EL DÍA 28/05/2021

CÓDIGO	largo	Material	Acabado	
399.71	2,6m.	aluminio	plata mate	2/20
399.72	2,6m.	aluminio	lacado blanco	2/20

CÓDIGO	Material	Acabado	
1304.12	PVC-fibra	gris	325m.
1304.11	PVC-fibra	marrón	325m.

BERNA 19 Kit de guías superior e inferior para puertas de armarios
Para serie NILA19.

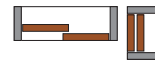

**BERNA
SP19**

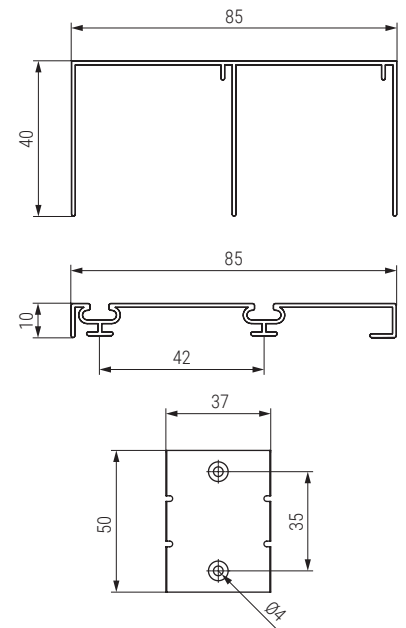
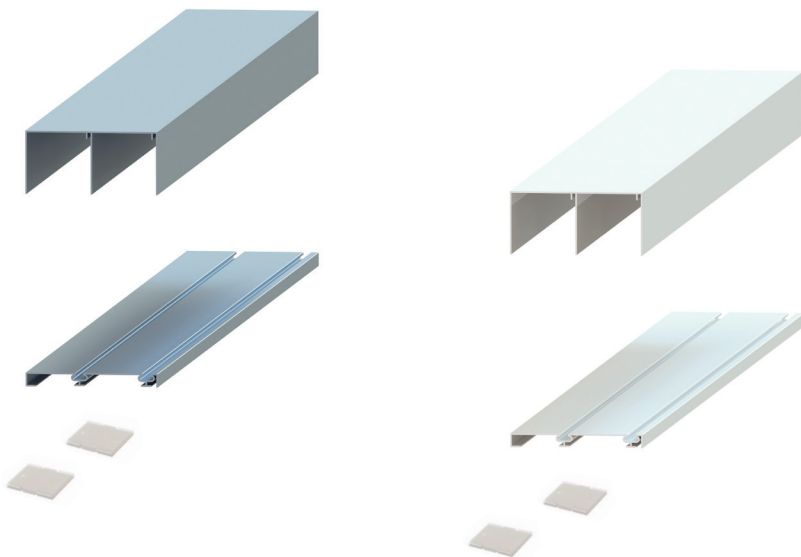

ACTUALIZADO EL DÍA 28/05/2021

• Incluye una guía superior, una guía inferior y piezas de anclaje.

CÓDIGO	largo	Material	Acabado	
399.81	2m.	aluminio	plata mate	1/3kit
399.82	3m.	aluminio	plata mate	1/3kit
399.84	2m.	aluminio	lacado blanco	1/3kit
399.85	3m.	aluminio	lacado blanco	1/3kit