

**NK 50 RETRAC** Sistema de herrajes para puertas correderas de paso en madera herraje embutido  
Sliding wooden door system with built-in fittings

**KLEIN®**  
**NK 50**  
retrac

NK 50 está diseñado para dividir ambientes a través de puertas de madera correderas

- Ideal para separación de cocinas, salones, baños, oficinas...
- Zona de paso sin riel en el suelo. Rodamientos con eje de fricción.
- Espacio mínimo entre puerta y perfil.
- Sistema de sujeción con herrajes empotrados "Retrac"
- Perfil de aluminio natural. Instalación a la pared o a techo.
- Topes retenedores para un cierre óptimo.

Sistemas testados hasta 100.000 ciclos según la norma EN 1527

NK has been designed to separate rooms by sliding wooden doors

- Ideal for partitioning kitchens, lounges, bathrooms, offices...
- Cleared passageway with no floor profile. Friction bearings
- Minimal gap between door and profile.
- Vertical support system with built-in fittings (Retrac).
- Natural aluminium profile. Wall or ceiling mounted.
- Stopper-brake for optimum closing.

Systems tested up to 100.000 cycles as per standard EN1527.



Aplicación con perfil y escuadra a la pared  
Application with profile and bracket for wall

Aplicación con perfil al techo  
Application with profile for ceiling

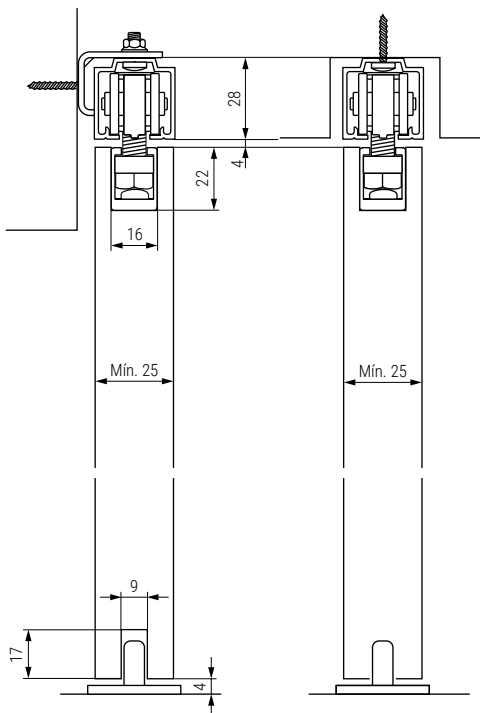

**NK 50 RETRAC** kit de herrajes para 1 puerta  
Kit fittings for one door



Código  
Code  
801.104

Carga  
Loading capacity  
50kg

1Kit

Información y complementos recomendados

	<p>Cód.801.101 2m Cód.801.102 3m</p>	<p>Cód.801.105</p>	<p>Instrucciones de montaje</p>	<p>Ficha técnica</p>
--	--	--------------------	---------------------------------	----------------------

Guía de aluminio anodizado NK50  
Aluminium anodized profile

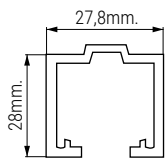
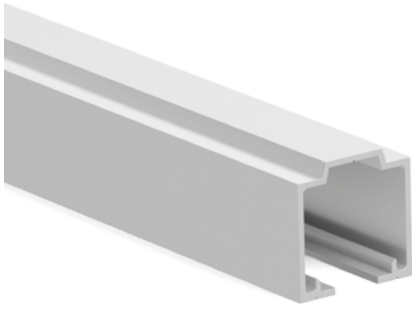

Código Code	Material	Acabado Finish	
801.101	aluminio	matt silver	2m.
801.102	aluminio	matt silver	3m.

Guía de aluminio anodizado NK85 - NK PAR40  
Aluminium anodized profile

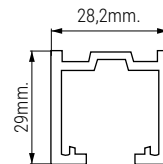
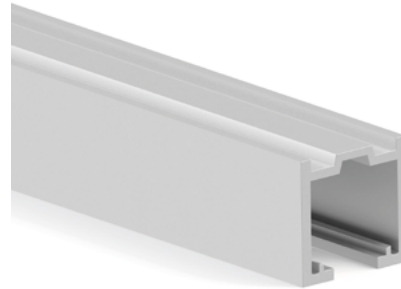

Código Code	Material	Acabado Finish	
801.111	aluminio	matt silver	2m.
801.112	aluminio	matt silver	3m.

Soporte de pared 6mm NK  
Wall support

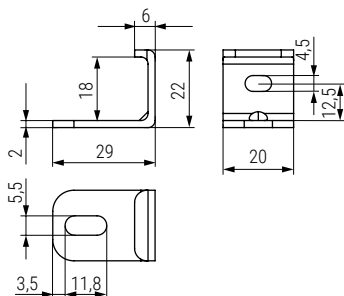

Código Code	Material	Acabado Finish	
801.105	acero/steel	zincado/ zinc plated	10

PERSA Bisagra asimétrica para puertas tipo libro  
Asymmetric hinge

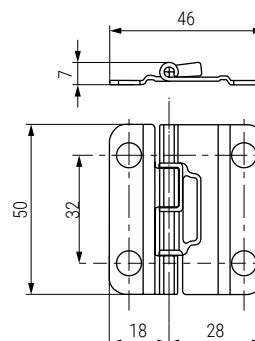

Código Code	Material	Acabado Finish	
1109.8	acero/steel	níquel/ nickel	600