

## SAMMY Paragolpe bi-material

Sammy  
by ALK®

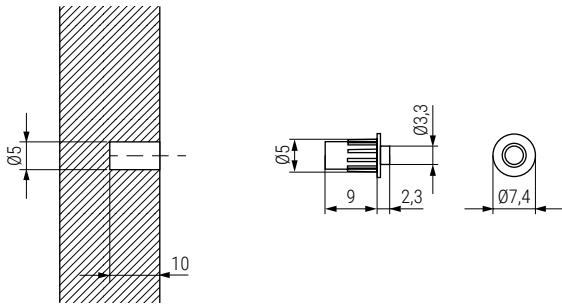

CÓDIGO	Material	Acabado	
595.57	plástico	antracita	1.000

## FENDER Paragolpes y antideslizantes adhesivos de goma EVA

### Lágrima semiesférica

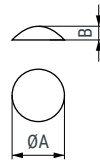

Código	ØA	B	Material	Acabado	
595.222	7	1,5	goma EVA	transparente	2.000
595.23	8	1,6	goma EVA	transparente	1.000
595.224	8	2,2	goma EVA	transparente	1.500
595.226	10	1,5	goma EVA	transparente	2.000
595.227	10	3	goma EVA	transparente	1.000
595.30	13	7,5	goma EVA	transparente	2.800

### Lágrima cilíndrica

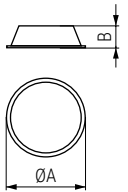
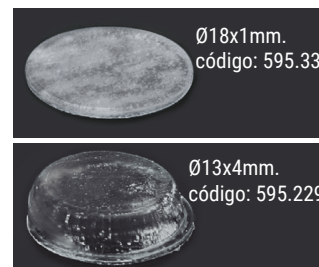

Código	ØA	B	Material	Acabado	
595.25	10	1	goma EVA	transparente	1.000
595.229	13	4	goma EVA	transparente	2.000
595.33	18	1	goma EVA	transparente	3.600

### Blister

Código	ØA	B	Material	Acabado	
595.122	7	1,5	goma EVA	transparente	50
595.123	8	1,6	goma EVA	transparente	50
595.124	8	2,2	goma EVA	transparente	50
595.126	10	1,5	goma EVA	transparente	50
595.127	10	3	goma EVA	transparente	50
595.130	13	7,5	goma EVA	transparente	40

### Blister

Código	ØA	B	Material	Acabado	
595.125	10	1	goma EVA	transparente	50
595.129	13	4	goma EVA	transparente	40
595.133	18	1	goma EVA	transparente	18

### Lágrima semiesférica

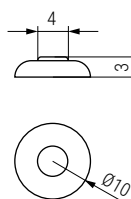
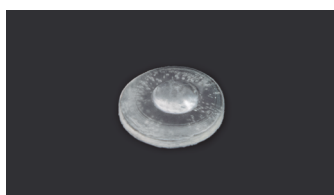

Código	Material	Acabado	
595.51	goma EVA	transparente	100

### Lágrima rectangular

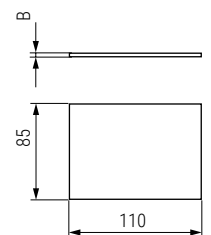

### Blister

Código	B	Material	Acabado		
595.141	0,5	poliuretano	transparente	1	50
595.142	0,8	poliuretano	transparente	1	50
595.143	1,6	poliuretano	transparente	1	50
595.144	3,2	poliuretano	transparente	1	50