

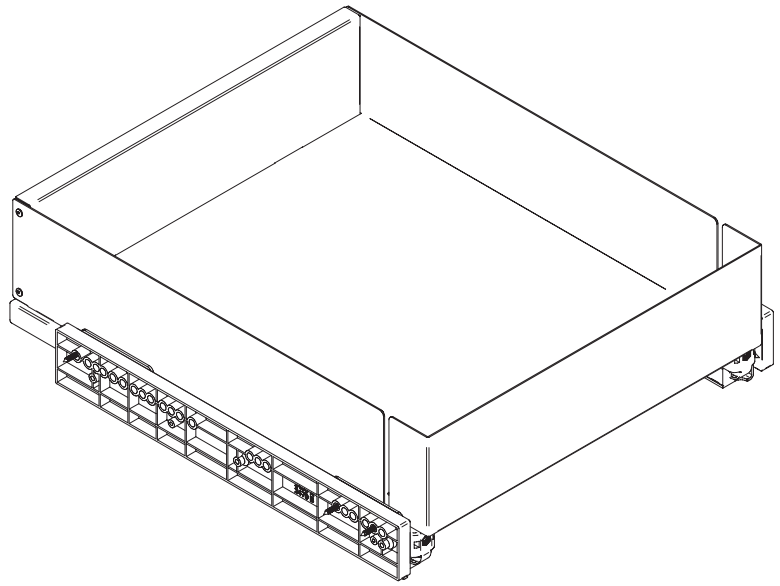



# Cassetto quattro lati

## Four-side drawer

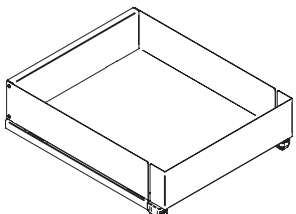
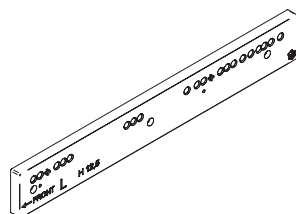
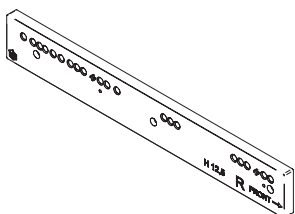
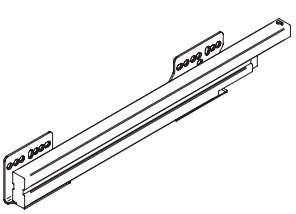
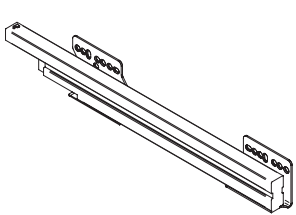
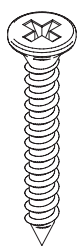

CCTGM40L  
CCTGM45L  
CCTGM60L  
CCTGM90L

 <b>Max: 30 Kg</b>	 <b>15 min</b>	 <b>x 1</b>	 <b>+</b>
<b>A</b>  <b>x 1</b>	<b>B</b>  <b>x 1</b>	<b>C</b>  <b>x 1</b>	<b>D</b>  <b>x 1</b>
<b>E</b>  <b>x 1</b>	<b>F</b>  <b>x 6</b> Ø4X30	<b>Info</b> 1) AVVERTENZA! Leggi attentamente le istruzioni prima del montaggio e segui ogni passaggio indicato. L'azienda declina ogni responsabilità dall'uso improprio del prodotto. Ogni uso improprio del prodotto può causare lesioni. Modifiche o manomissioni del prodotto, annullano ogni condizione di garanzia. 2) Smaltisci i diversi materiali secondo regolamentazioni della tua città.  1) WARNING! Read the instructions carefully before assembly and follow each step indicated. The company declines all responsibility for improper use of the product. Any improper use of the product can cause injury. Modifications or tampering with the product void any warranty conditions. 2) Proceed to dispose of the different materials according to your city regulations.	

	<b>WARNING (proposition 65 compliant)</b> www.P65Warnings.ca.gov		
	CHEMICAL	LISTED AS CAUSING	
	Formaldehyde (gas)	Cancer	

1

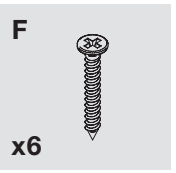
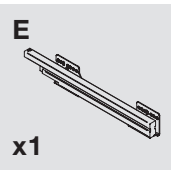
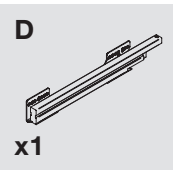
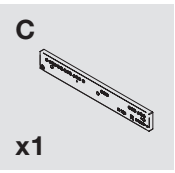
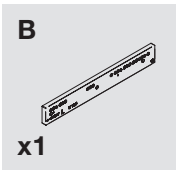

**Dx = Sx**

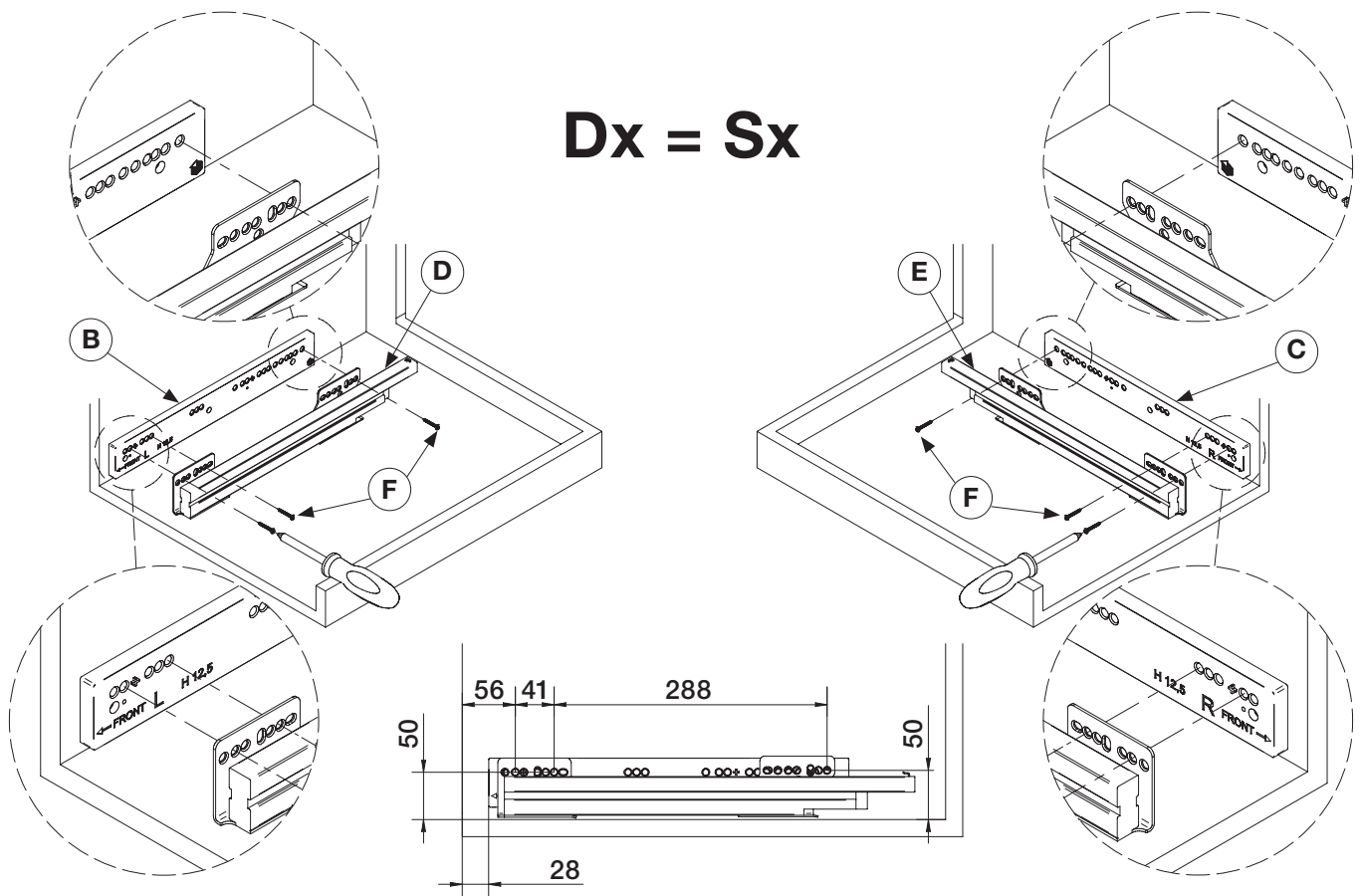

2

