

**CALIBRO** Sistema ensamble excéntrico Ø35mm.  
Excenter fixing system Ø35

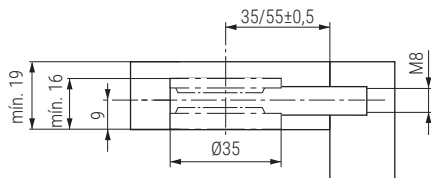

Excéntrica Ø35mm. **CALIBRO**  
Excenter Ø35mm

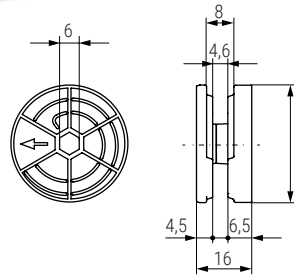

**ZINC  
ALLOY**

Código Code	Material	Acabado Finish	
428.11	zamak/zamac	bruto/brut	550

**Tirante M8**  
Excenter screw

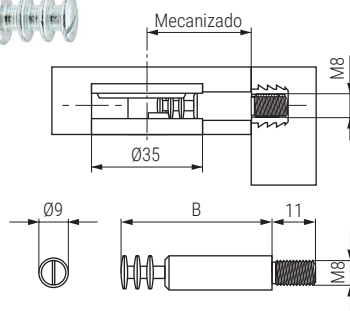
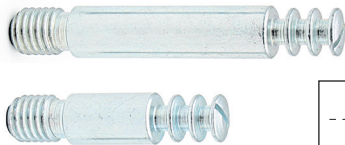

Código Code	Mecanizado Machining	B	Material	Acabado Finish	
428.32	35	29	acero/steel	zincado/zinc	500
428.3	55	48	acero/steel	zincado/zinc	500
428.13	57	49,5	acero/steel	zincado/zinc	500

**Tirante 90° 50/50mm.**  
Excenter screw

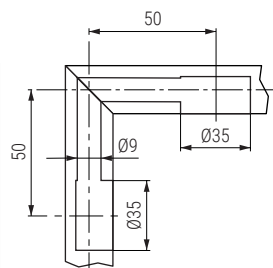

Código Code	Material	Acabado Finish	
428.8	acero/steel	zincado/zinc	500

EMPRESA ASOCIADA  
**AIDIMME**  
INSTITUTO TECNOLÓGICO

**TAPPO 35** Tapa embellecedora Ø40mm.  
Excenter tape Ø40

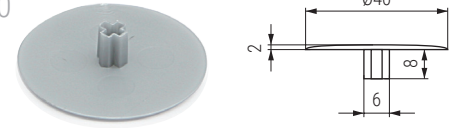

Código Code	Material	Acabado Finish	
9030.120	plástico/plastic	gris/grey	2.000
9030.202	plástico/plastic	negro/black	2.000
9030.305	plástico/plastic	blanco/white	2.000
9030.303	plástico/plastic	arena/sand	2.000
9030.302	plástico/plastic	lino/linen	2.000
9030.105	plástico/plastic	marrón/brown	2.000
9030.304	plástico/plastic	crema/cream	2.000

**CANELA 35** Tapa embellecedor embutir Ø35mm.  
Excenter tape Ø35mm

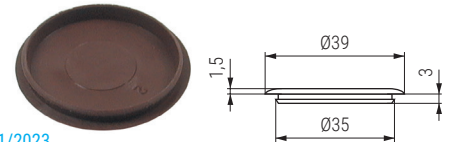

ACTUALIZADO EL DIA 10/11/2023

Código Code	Material	Acabado Finish	
9030.75	plástico/plastic	blanco/white	1.500
9030.196	plástico/plastic	gris/grey	1.500
9030.322	plástico/plastic	negro/black	1.500
9030.323	plástico/plastic	arena/sand	1.500
9030.74	plástico/plastic	marrón/brown	1.500
9030.321	plástico/plastic	crema/cream	1.500

**Tirante doble para unión de tableros**  
Excenter screw



cód. 428.9

cód. 428.4

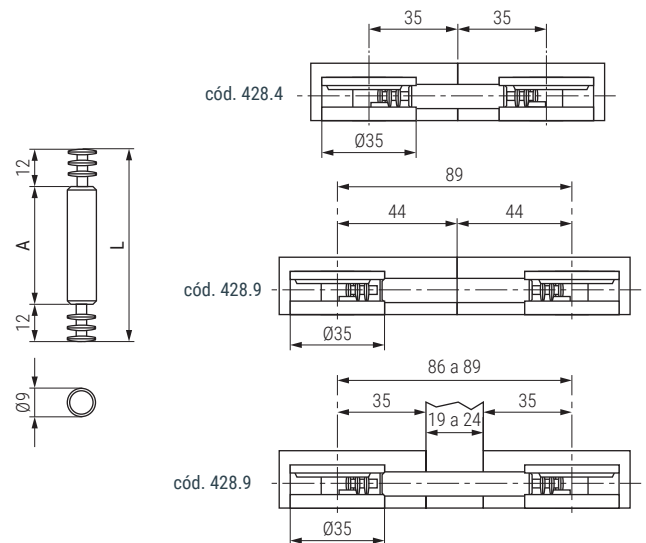

Código Code	L	A	Material	Acabado Finish	
428.4	55	31	acero/steel	zincado/zinc	500
428.9	74	50	acero/steel	zincado/zinc	250